

FEATURES

- Wide variety of actuators
- High precision
- High breaking capacity(15A)
- Wide operating speed range



SPECIFICATIONS

RATINGS

Rated voltage (V)	Non-inductive load(A)				Inductive load (A)				Inrush current (A)	
	Resistive load		Lamp load		Inductive load		Motor load			
	NC	NO	NC	NO	NC	NO	NC	NO	NC	NO
125 VAC	15	3	1.5	15	5	2.5	30 max.	15 max.		
250 VAC	15	2.5	1.25	15	3	1.5				
500 VAC	3	1.5	0.75	2.5	1.5	0.75				
8 VDC	15	3	1.5	15	5	2.5				
14 VDC	15	3	1.5	10	5	2.5				
30 VDC	6(2)	3	1.5	5	5	2.5				
125 VDC	0.4	0.4	0.4	0.05	0.05	0.05				
250 VDC	0.2	0.2	0.2	0.03	0.03	0.03				

Screw type

None

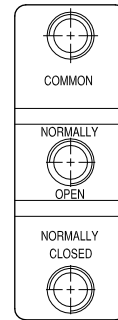

Solder Type

-A

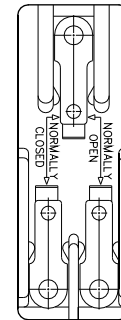

Tab Type

-C

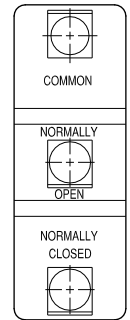

CHARACTERISTICS

Operating speed	0.01mm to 1m/sec
Operating frequency	Mechanically:240 operations/min Electrically:20 operations/min
Contact resistance	15m max.(initial)
Insulation resistance	100M max.(at 500 VDC)
Dielectric strength	1,000 VAC,50/60Hz, for 1 minute be-tween non-continuous terminals; 2,000 VAC,50/60Hz, for 1 minute be-tween current-carrying part and ground
Vibration	Mechanical durability: 10 to 55HZ,1.5mm double amplitude
Shock	Mechanical durability: approx.1,000m/sec ² (approx.100G's) Malfunction durability: Approx 300m/sec ² (approx.30G's)
Ambient temperature	General purpose type:-25°C to +80°C Sealed type:-15°C to +80°C
Humidity	General purpose type: 85% RH max. Sealed type: 95%RH max.
Service life	Mechanically: 20,000,000 operations min. Electrically:500,000 operations min.
Weight	Approx. 22 to 58g

CONTACT CONFIGURATION

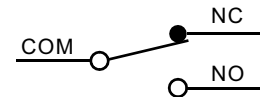

DEFINITIONS OF OPERATING CHARACTERISTICS:

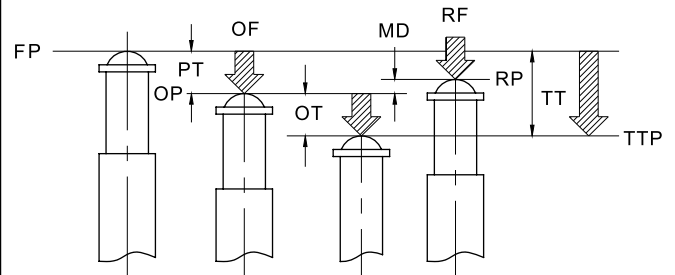

Operate

Release

OF: Operating Force

TTP: Total Travel Position

RF: Releasing Force

PT: Pre travel

TF: Total Force

OT: Overtravel

FP: Free position

MD: Movement Differential

OP: Operating Position

TT: Total Travel

RP: Releasing Position

OPERATION CHARACTERISTICS

Type	TM-1300	TM-1301	TM-1303	TM-1305	TM-1306	TM-1307	TM-1308	TM-1309
OF Max.	350g	300g	300g	350g	350g	350g	350g	350g
RF Min.	114g	50g	50g	114g	114g	114g	114g	114g
PT Max.	0.4mm	4mm	4mm	0.4mm	0.4mm	0.4mm	0.4mm	0.4mm
OT Min.	0.13mm	1.6mm	1.6mm	1.6mm	1.6mm	5.5mm	3.58mm	3.58mm
MD Max.	0.05mm	1.3mm	1.3mm	0.05mm	0.05mm	0.05mm	0.05mm	0.05mm
FP Max.		20.6mm	31.8mm					
OP	15.9±0.4mm	17.4±0.8mm	28.6±0.8mm	28.2±0.5mm	21.5±0.5mm	21.8±0.8mm	33.4±1.2mm	33.4±1.2mm

DIMENSIONS

TM-1300

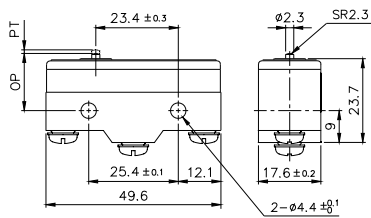

TM-1306

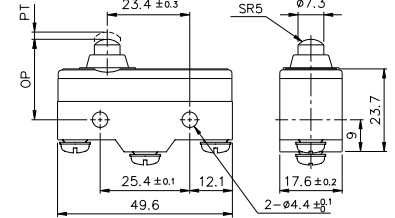

TM-1301

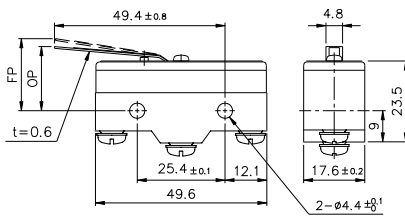

TM-1307

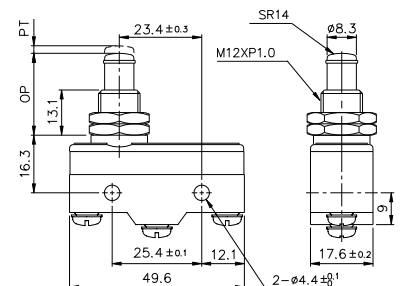

TM-1303

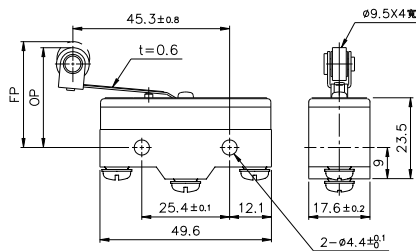

TM-1308

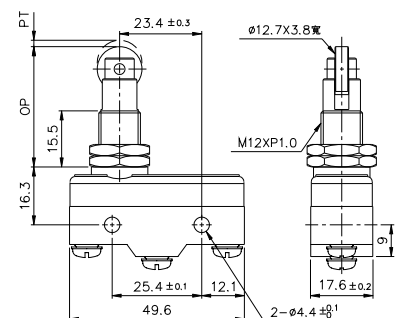

TM-1305

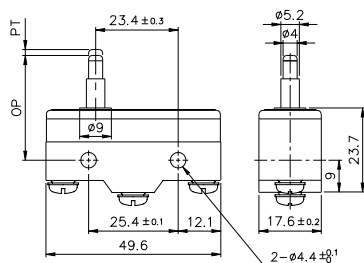

TM-1309

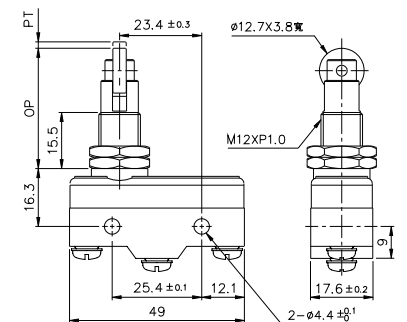

OPERATION CHARACTERISTICS

Type	TM-1701	TM-1702	TM-1703	TM-1704	TM-1705	TM-1707	TM-1709	TM-1743
OF Max.	70g	160g	100g	160g	10g	170g	100g	160g
RF Min.	14g	28g	22g	42g	3g	42g	21g	42g
PT Max.	10mm	5mm	7.1mm	2.7mm	20mm	2.7mm	7.3mm	2.7mm
OT Min.	5.6mm	2mm	4mm	2.4mm	5.6mm	2.4mm	4mm	2.4mm
MD Max.	1.27mm	1mm	1.02mm	0.5mm	4mm	0.5mm	1.6mm	0.5mm
FP Max.	28.2mm	24.8mm	36.5mm	32.5mm		33.3mm	47.5mm	43.6mm
OP	19±0.8mm	19±0.4mm	30.2±0.8mm	30.2±0.4mm	19±0.8mm	31±0.4mm	41.2±0.8mm	41.3±0.8mm

DIMENSIONS

TM-1701

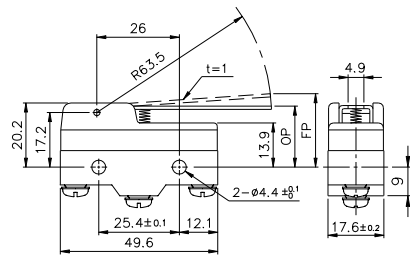

TM-1705

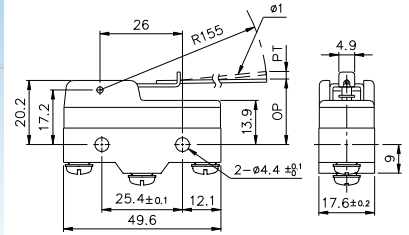

TM-1702

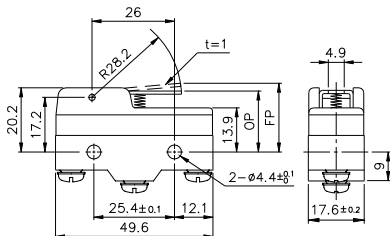

TM-1707

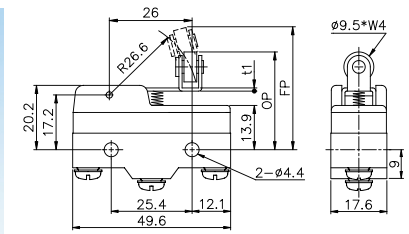

TM-1703

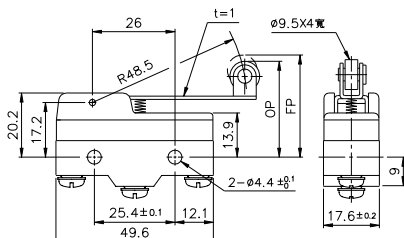

TM-1709

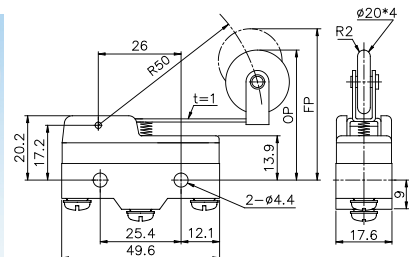

TM-1704

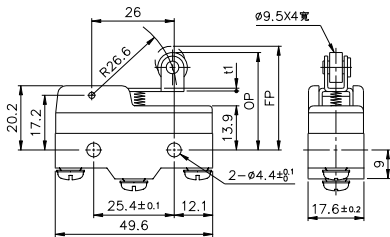

TM-1743

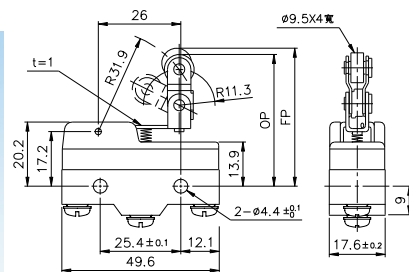

tend MICRO SWITCH (SEALED TYPE)

TM

Surrounding joints are sealed by epoxy, and waterproof, oil tight rubber boot.
Dust-preventive, waterproof and oil tight.

OPERATION CHARACTERISTICS

Type	TM-1300-1	TM-1301-1	TM-1303-1	TM-1305-1	TM-1306-1	TM-1307-1	TM-1308-1	TM-1309-1
OF max.	500g	400g	400g	500g	500g	500g	500g	500g
RF min.	114g	50g	50g	114g	114g	114g	114g	114g
PT max.	0.4mm	4mm	4mm	0.4mm	0.4mm	0.4mm	0.4mm	0.4mm
OT min.	0.13mm	1.6mm	1.6mm	1.6mm	1.6mm	5.5mm	3.58mm	3.58mm
MD max.	0.05mm	1.3mm	1.3mm	0.05mm	0.05mm	0.05mm	0.05mm	0.05mm
FP max.		20.6mm	31.8mm					
OP	15.9±0.4mm	17.4±0.8mm	28.6±0.8mm	28.2±0.5mm	21.5±0.5mm	21.8±0.8mm	33.4±1.2mm	33.4±1.2mm

DIMENSIONS

TM-1300-1

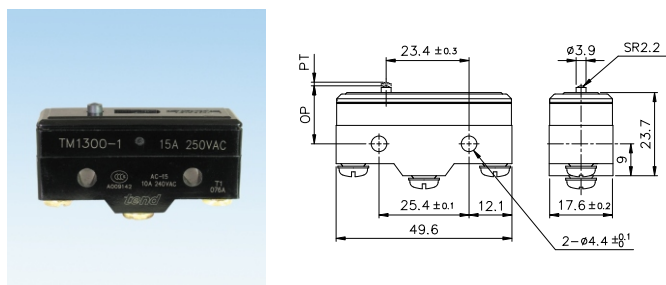

TM-1306-1

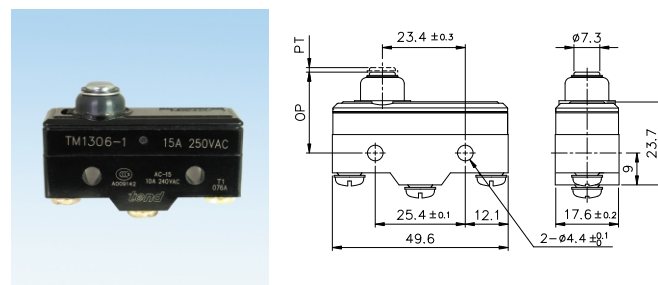

TM-1301-1

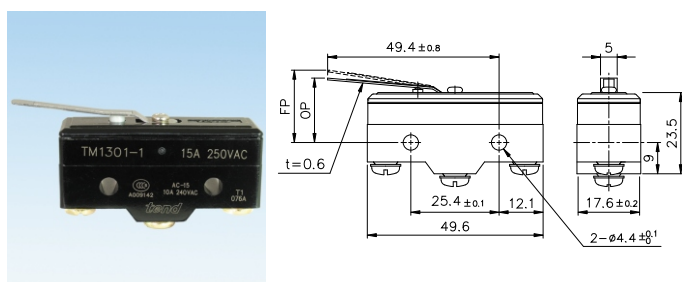

TM-1307-1

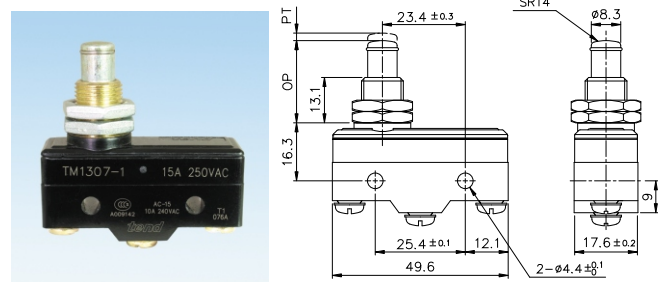

TM-1303-1

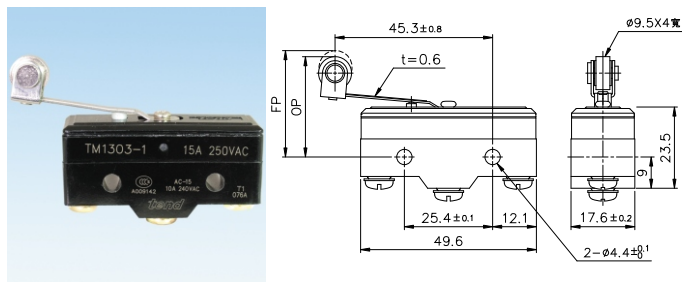

TM-1308-1

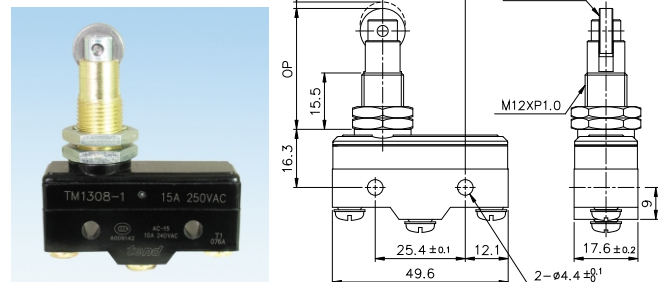

TM-1305-1

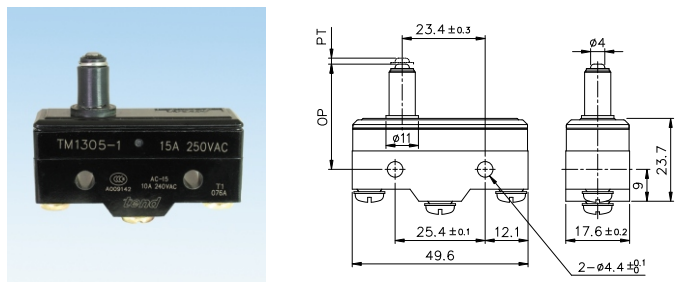

TM-1309-1

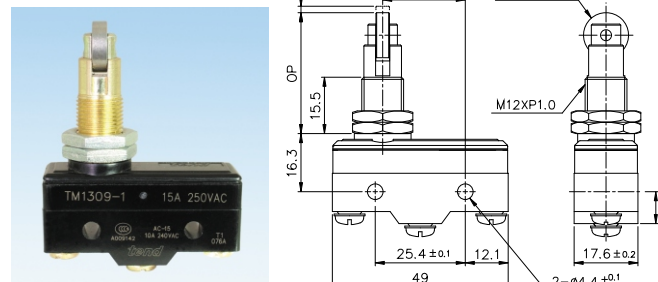

OPERATION CHARACTERISTICS

Type	TM-1701-1	TM-1702-1	TM-1703-1	TM-1704-1	TM-1705-1	TM-1707-1	TM-1709-1	TM-1743-1
OF Max.	100g	190g	130g	190g	40g	200g	130g	190g
RF Min.	14g	28g	21g	42g	3g	42g	21g	50g
PT Max.	10mm	5mm	7.1mm	2.7mm	20mm	2.7mm	7.3mm	2.7mm
OT Min.	5.6mm	2mm	4mm	2.4mm	5.6mm	2.4mm	4mm	2.4mm
MD Max.	2mm	1mm	1.6mm	0.8mm	4mm	0.5mm	1.6mm	0.8mm
FP Max.	28.2mm	25mm	36.5mm	32.9mm		33.3mm	47.5mm	43.6mm
OP	19±0.8mm	19±0.8mm	30.2±0.8mm	30.2±0.4mm	19±0.8mm	31±0.4mm	41.2±0.8mm	41.3±0.8mm

DIMENSIONS

TM-1701-1

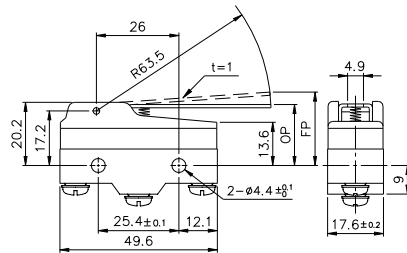

TM-1705-1

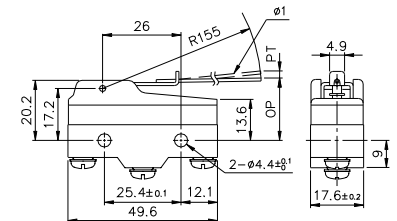

TM-1702-1

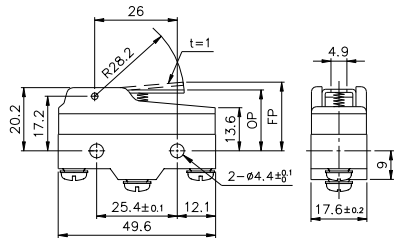

TM-1707-1

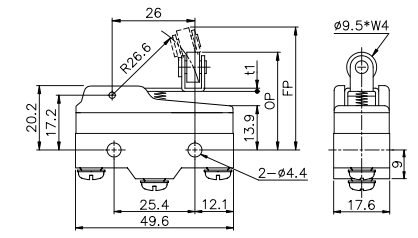

TM-1703-1

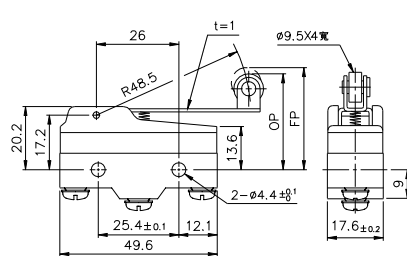

TM-1709-1

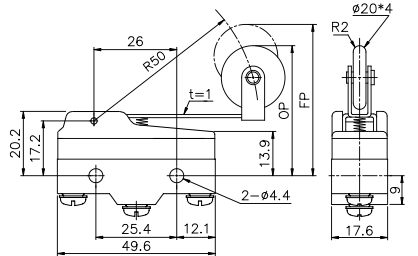

TM-1704-1

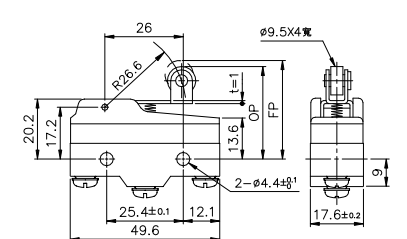

TM-1743-1

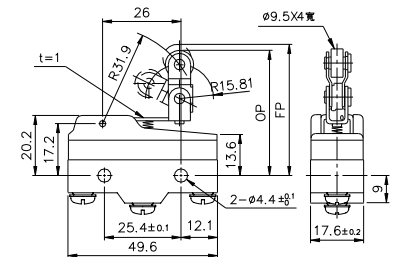

FEATURES

- Similar to TEND TM series micro switch
- Put a magnet in the contact block to prevent fire
- The safety switch for dc usage

SPECIFICATIONS

RATINGS

Rated Voltage (V)	Non-inductive load(A)		Inductive load(A)						
	Resistive load		Lamp load		Inductive load		Motor load		
	NC	NO	NC	NO	NC	NO	NC	NO	
8 VDC	15	3	1.5	15	15	5	2.5		
14 VDC	15	3	1.5	15	10	5	2.5		
30 VDC	15	3	1.5	10	10	5	2.5		
125 VDC	10	3	1.5	7.5	6	5	2.5		
250 VDC	3	3	1.5	2	1.5	2	1.5		

Notes: 1. inductive load has a power factor of 0.4 min. (ac) and a time constant of 7 msec. Max. (dc)
 2. lamp load has an inrush current of 10 times the steady-state current, while motor load has an inrush current of 6 times the steady-state current.

CHARACTERISTICS

Operating speed	0.1mm~1m/s
Operating frequency	Mechanically 240 operations/min Electrically 20 operations/min
Contact resistance	15m max.
Insulation resistance	100M min.(at 500VDC)
Dielectric strength	1,500VAC,50/60Hz for 1minute
Vibration	10 to 55Hz, 1.5mm double amplitude
Shock	Mechanically approx. 1,000m/s ² (approx. 100G's) Electrically. 300m/s ² (approx. 30G's)
Ambient temperature	-25~+80°C
Ambient humidity	Below 85%RH
Service life	Mechanically, 10,000,00operations/min Electrically, 100,000 operations/min
Weight	Approx.27g~36g

CONTACT CONFIGURATION

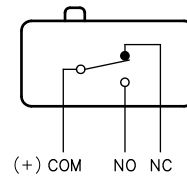

DIMENSION

TMD-1701

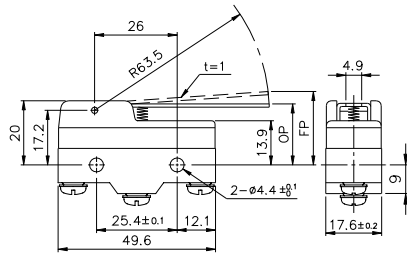

TMD-1703

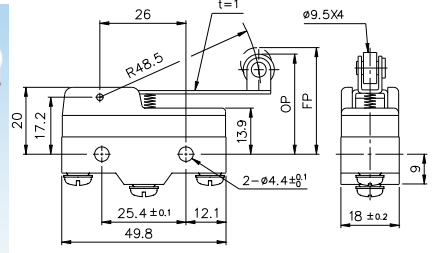

TMD-1702

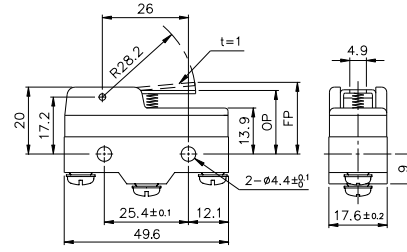

TMD-1704

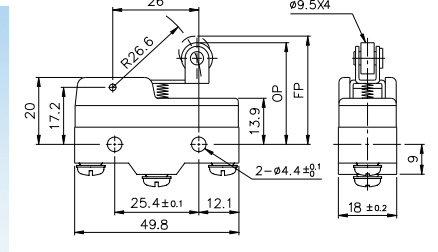

CHARACTERISTICS

Type	TMD-1701	TMD-1702	TMD-1703	TMD-1704
OF max.	110gf(1.08N)	250gf(2.45N)	145gf(1.42N)	220gf(2.16N)
RF min.	14gf(0.14N)	32gf(0.31N)	21gf(0.21N)	35gf(0.34N)
OT min.	4.8mm	2.1mm	4mm	2.4mm
MD max.	3.9mm	1.7mm	3mm	1.7mm
FP max.	34.6mm	25.5mm	40.5mm	37.1mm
OP	19.8±0.8mm	19.8±0.4mm	32.2±0.8mm	32.2±0.8mm

FEATURES

- Wide variety of actuators. ● High precision.
- Wide operating speed range.

MODEL DESIGNATION

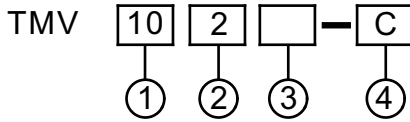

DESIGNATION	Signal	DESCRIPTION
1. Rating	10 16 21	10A 16A 21A
2. Actuator	0 1 2 3 4 5 6	Push Button Type Long Lever Type Short Lever Type Long Roller Type Short Roller Type Extra Lever Type Crank Lever Type
3. Contact	A AS B BS None S	1A(com bottom terminal) 1A(com side terminal) 1B(com bottom terminal) 1B(com side terminal) 1C(com bottom terminal) 1C(com side terminal)
4. Terminal	C D	#250 Terminal #187 Terminal

TYPES

Actuator	Com Terminal	Rating Contact	Rating Terminal	10A	16A	21A	
Push Button Type	Side terminal	1C	Terminal type of #187	TMV100-C/D	TMV160-C/D	TMV210-C/D	
Long Lever Type				TMV101-C/D	TMV161-C/D	TMV211-C/D	
Short Lever Type				TMV102-C/D	TMV162-C/D	TMV212-C/D	
Long Roller Type				TMV103-C/D	TMV163-C/D	TMV213-C/D	
Short Roller Type				TMV104-C/D	TMV164-C/D	TMV214-C/D	
Extra Lever Type				TMV105-C/D	TMV165-C/D	TMV215-C/D	
Crank Lever Type			Bottom terminal	Terminal type of #250	TMV106-C/D	TMV166-C/D	TMV216-C/D
					TMV100S-C/D	TMV160S-C/D	TMV210S-C/D
					TMV101S-C/D	TMV161S-C/D	TMV211S-C/D
					TMV102S-C/D	TMV162S-C/D	TMV212S-C/D
					TMV103S-C/D	TMV163S-C/D	TMV213S-C/D
					TMV104S-C/D	TMV164S-C/D	TMV214S-C/D

Type and shape of terminal

Type of terminal	#187 quick connect	#250 quick connect
Bottom terminal		
Side terminal		
Terminal size		

CONTACT CONFIGURATION

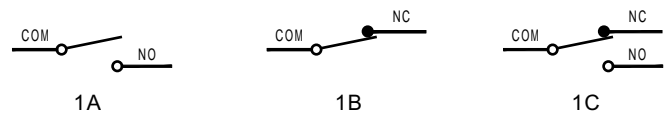

MOUNTING HOLES

Using M3 screw, washer and spring washer as install. The twist force of 0.39~0.59N.m or 4~6Kg.cm is recommended and applicable.

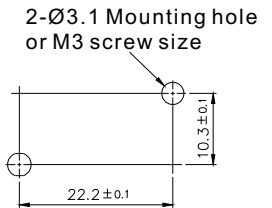

SPECIFICATIONS

RATINGS

Item Type	Rated voltage (V)	Non-inductive load(A)		Inductive load(A)		Inrush current (A)	
		Resistive load	Lamp load	Inductive load	Motor load	NC	NO
10A	250 VAC	10	1.5	6	2	24 max.	NC NO
	8 VDC	10	3	6	3		
	30 VDC	6	3	6	3		
	125 VDC	0.6	0.1	0.6	0.1		
	250 VDC	0.3	0.05	0.3	0.05		
16A	250 VAC	16	2	10	3	40 max.	NC NO
	8 VDC	16	4	10	6		
	30 VDC	10	4	10	4		
	125 VDC	0.6	0.1	0.6	0.1		
	250 VDC	0.3	0.05	0.3	0.05		
21A	250 VAC	21	3	12	4	50 max.	NC NO
	8 VDC	21	5	12	7		
	30 VDC	14	5	12	5		
	125 VDC	0.6	0.1	0.6	0.1		
	250 VDC	0.3	0.05	0.3	0.05		

CHARACTERISTICS

Item	Type	TMV 10	TMV 16	TMV 21
Operating speed		0.1mm~1m/s (push button type)		
Operating frequency		Mechanically:240 operations/min electrically :20 operations/min		
Insulation resistance		100M min. (At 500 VDC)		
Contact resistance		15m max. (Initial value)		
Dielectric strength	Non-continuous terminals	1,000VAC,50/60Hz for 1 minute		
	between non-continuous terminals	1500VAC, 50/60Hz for 1 minute	2000VAC,50/60Hz for 1 minute	
Vibration	Malfunction	10~55Hz, double amplitude 1.5mm		
Shock	Mechanical durability	1,000m/sec ² { approx.100G's}		
	Malfunction	200m/sec ² { approx.20G}	300m/sec ² { approx.30G}	
Service life	Mechanically	20,000,000 operations min		
	Electrically	300,000 operations min	100,000 operations min	
Ambient temperature		General purpose type:-25° to +65°C		
Ambient Humidity		General purpose type:85%RH max General purpose type:+5° to +35°C		
Weight		Approx:7.2~8g		

OPERATION CHARACTERISTICS

Type	TMV100 TMV160 TMV210	TMV101 TMV161 TMV211	TMV102 TMV162 TMV212	TMV103 TMV163 TMV213	TMV104 TMV164 TMV214	TMV105 TMV165 TMV215	TMV106 TMV166 TMV216
OF Max.	200g	125g	200g	125g	240g	70g	125g
RF Min.	50g	14g	50g	14g	50g	6g	14g
PT Max.	1.4mm	4.0mm	1.6mm	4.0mm	1.6mm	9.0mm	4.0mm
OT Min.	0.8mm	1.6mm	0.8mm	1.6mm	0.8mm	3.2mm	1.6mm
MD Max.	0.5mm	1.5mm	0.6mm	1.5mm	0.6mm	2.8mm	1.5mm
OP	14.7 ±0.5mm	15.2 ±1.2mm	15.2 ±0.5mm	20.7 ±1.2mm	20.7 ±0.6mm	15.2 ±2.5mm	18.7 ±1.2mm

DIMENSIONS

TMV100-C

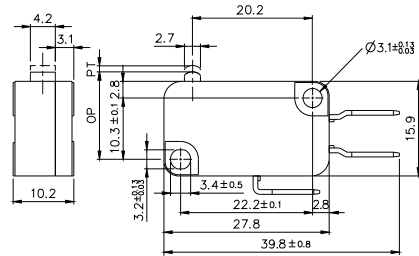

TMV104-C

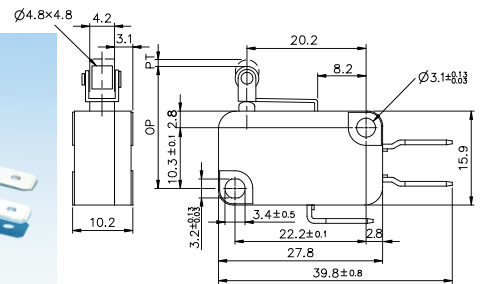
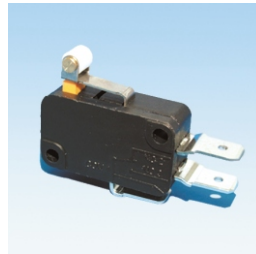

TMV101-C

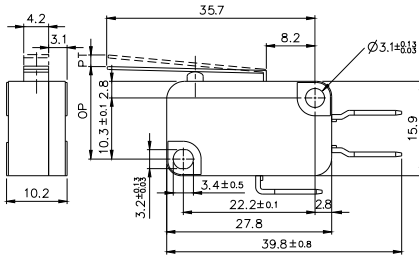
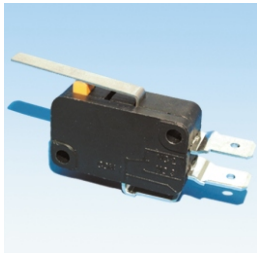

TMV105-C

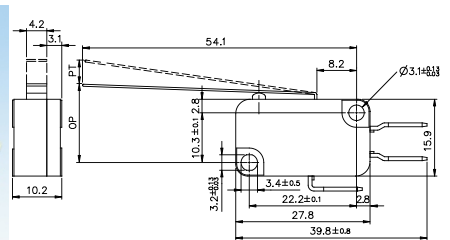
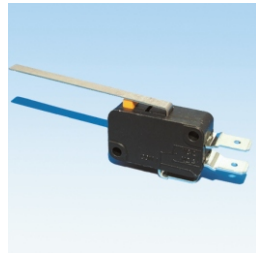

TMV102-C

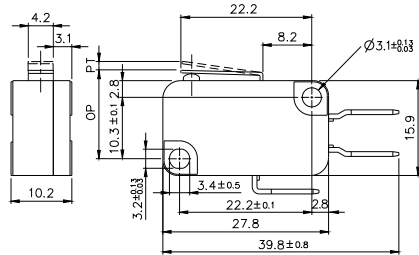

TMV106-C

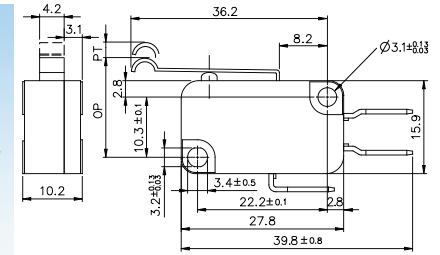
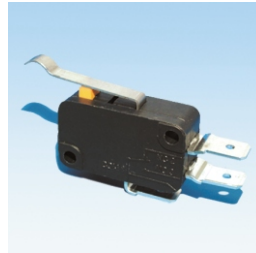

TMV103-C

